

# Webinar II April 2023

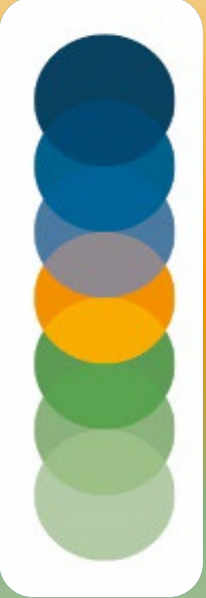

# SAPPMA

southern african plastic pipe manufacturers association



# Learn to Lead



Conformity assessment can be applied to products, processes, services, systems, installations, projects, data, designs, materials, claims, persons

or organisations and also to those bodies that perform conformity assessment activities

## SANS ISO 17000 Conformity Assessment Vocabulary and General Principles

### NEED TO DEMONSTRATE FULFILMENT OF SPECIFIED REQUIREMENTS

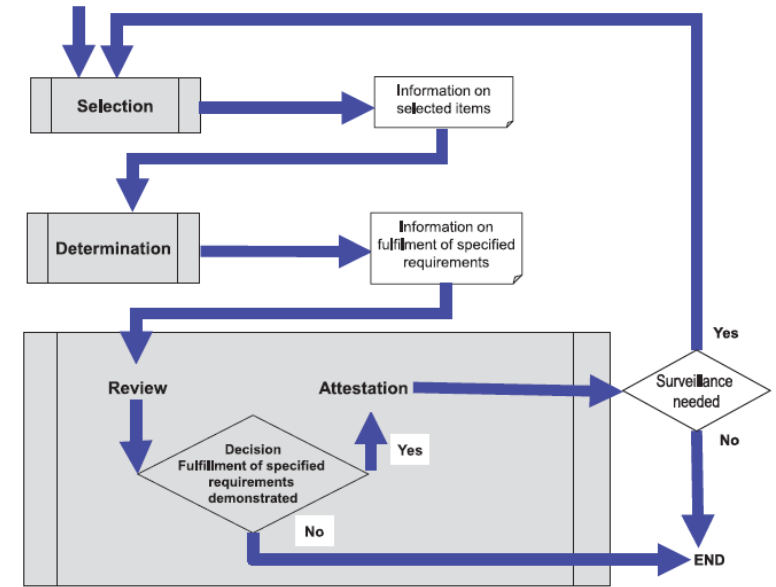

- Key
- shape A conformity assessment function
- shape B output from a function or input to the next function
- shape C decision point

Figure A.1 — Functional approach to conformity assessment

# INSTALLATION

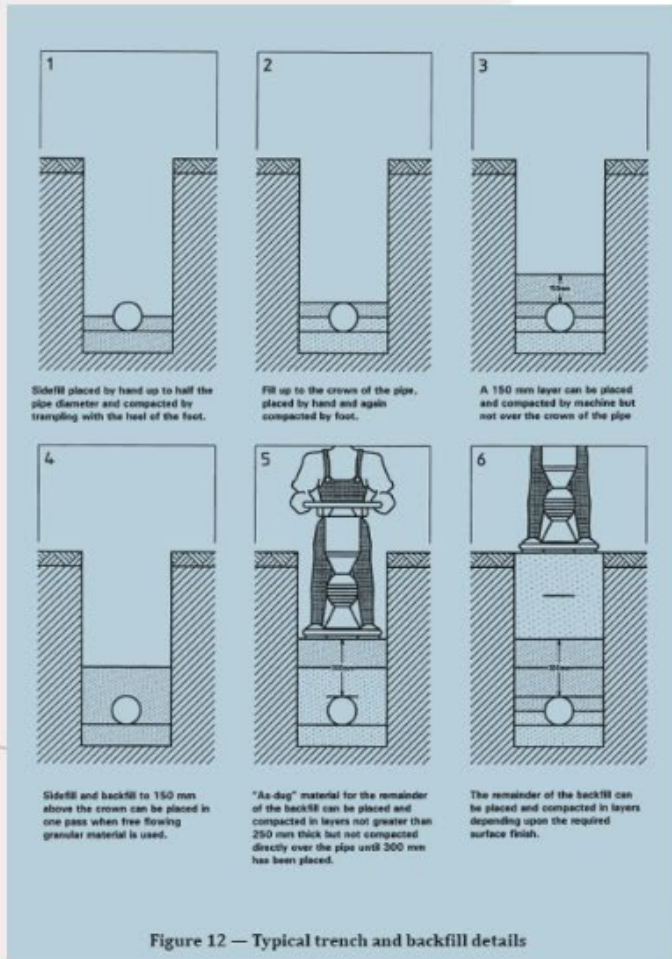

Figure 12 — Typical trench and backfill details

## 9.2 Pipe deflection

Deflections occurring immediately after installation as a function of pipe ring stiffness ( $SN$ ) and type of installation.

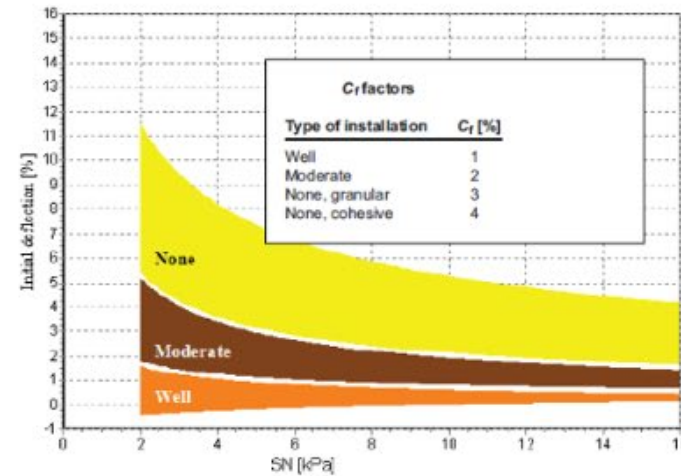

Figure 14 — Pipe deflection immediately after installation, as a function of pipe stiffness ( $SN$ ) and type of installation

Installation of buried pressure pipes can be grouped in roughly three groups, based on the embedment material used and the treatment that it was given. In Figure 13, these three groups are schematically presented. Depending on the way the installation is carried out, pipes will deflect during the installation. In Figure 14, values are given for initial pipe deflection depending on the type of embedment and stiffness class of the pipe.

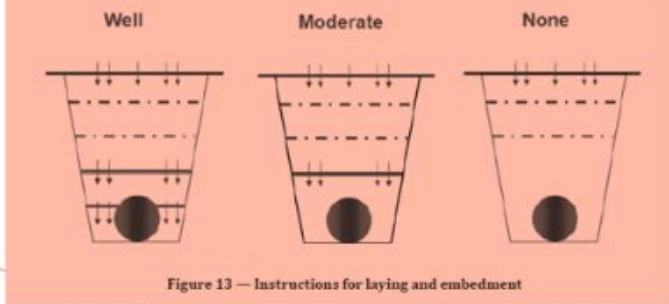

Figure 13 — Instructions for laying and embedment

Experimental work over a period of 40 years have shown that pipe deflection increases in the course of time irrespective if the pipe is made out of visco-elastic material or linear elastic material. In the TEPPFA project, it has been explained that this increase is not due to creep of the pipe material but due to settlement of the soil.

In order to determine the final deflections occurring after complete settlement of the soil, the values as listed in Table 6 should be added.

Table 6 — Cf factors to obtain the final deflection

| Type of installation | Cf Settlement add-on value [%] |
|----------------------|--------------------------------|
| Well                 | 1                              |
| Moderate             | 2                              |
| None                 | 4                              |

The final deflection can be calculated as follows:

$$\text{Final deflection} = \text{Initial deflection} + C_f$$

(6)

It is important to note that the Cf factor covers the effect of depth of cover, groundwater, and traffic load, as these are all playing an important role in the settlement process.

# Pipes and joints made of oriented unplastized poly(vinyl chloride) (PVC-O) for the conveyance of water under pressure



“PVC-O”



Helmuth Rijnhart, Technology Manager PVC Pipe Extrusion at Rollepaal B.V (Netherlands), will share some of his experience, essential points, and information to consider when manufacturing PVC-O pipes.

We invite you to join us for a SAPPMA Webinar to learn from his wealth of understanding of the subject matter.

Access to clean water is one of the biggest health issues of our time

Rollepaal is leading the change in sustainable, cost and material-saving solutions for water pipe production.

# SAPPMA

southern african plastic pipe manufacturers association



*Presenter*

**SAPPMA Webinar II 2023**

**13 April 2023**



Helmuth Rijnhart

**rollepaal** 



**SAPPMA**  
southern african plastic pipe manufacturers association 





# Rollepaal Experience

- Developing plastic pipe extrusion technology since 1963
- Dedicated to pipe extrusion
- Independent worldwide supply of equipment
- **Focus on sustainable solutions**



# Sustainable solutions

- Reduce use of resources
- Reduce use of plastic
- Reduce use of energy



# Sustainable solutions

## Non-Pressure Pipe:

- Direct addition of mineral fillers (CaCO<sub>3</sub>, BaSO<sub>4</sub>)
- Multilayer foamcore pipe
  - Weight saving
  - Addition of fillers in the core layer
  - Use of factory scrap in the core layer
  - Use of post consumer scrap in the core layer





# Sustainable solutions

## Pressure Pipe:

- PVC-O (Oriented PVC)



# PVC-O presentation

1. What is PVC-O?
2. Why use PVC-O?
3. Batch process or Continuous process?
4. Rblue line step by step



# What is PVC-O?

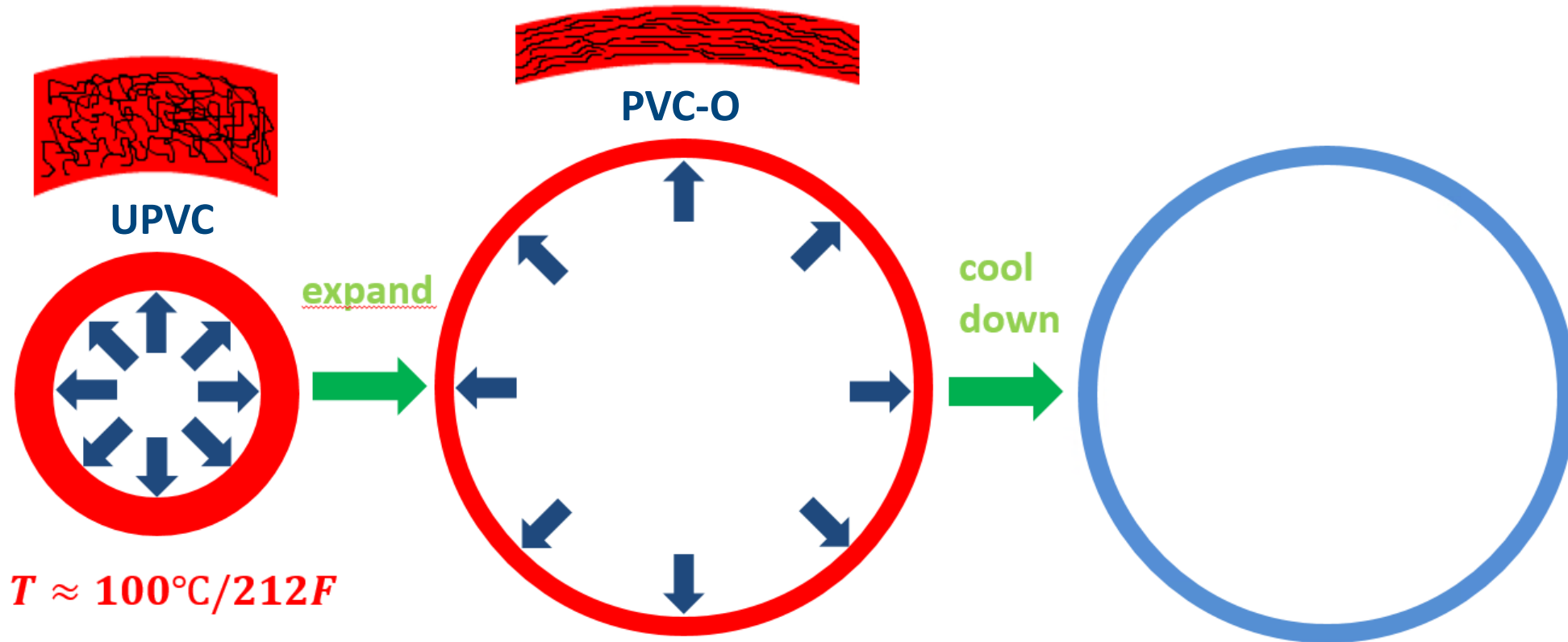



# PVC-O = bi-oriented

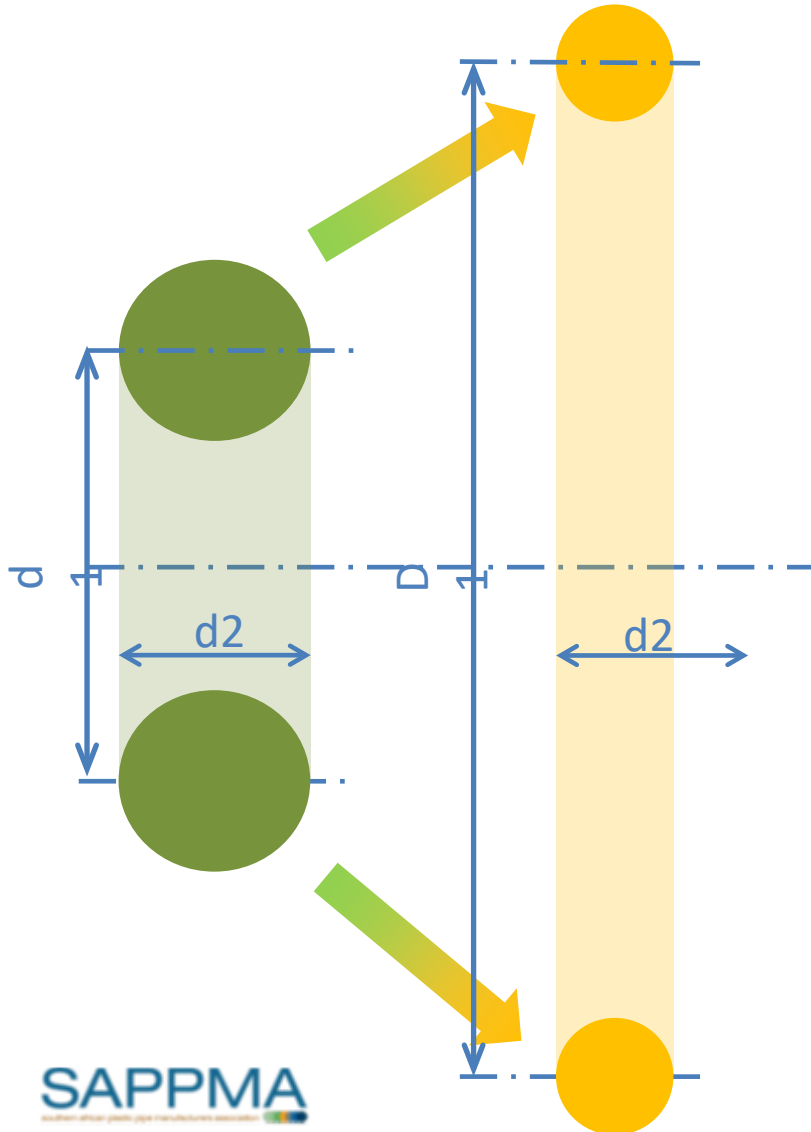



# PVC-O = bi-oriented

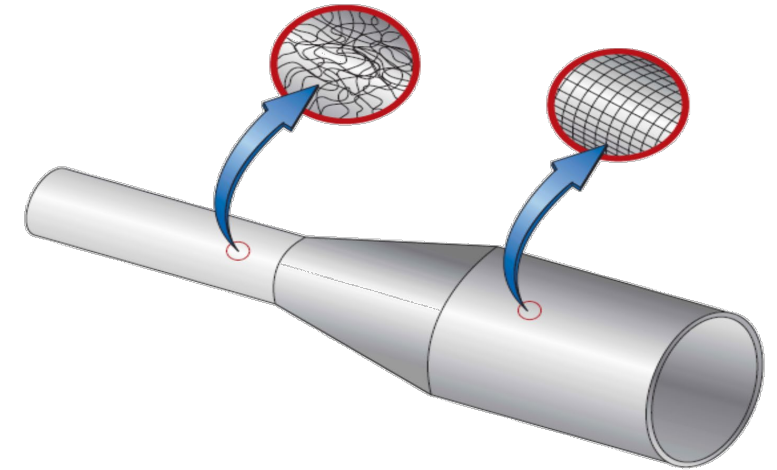
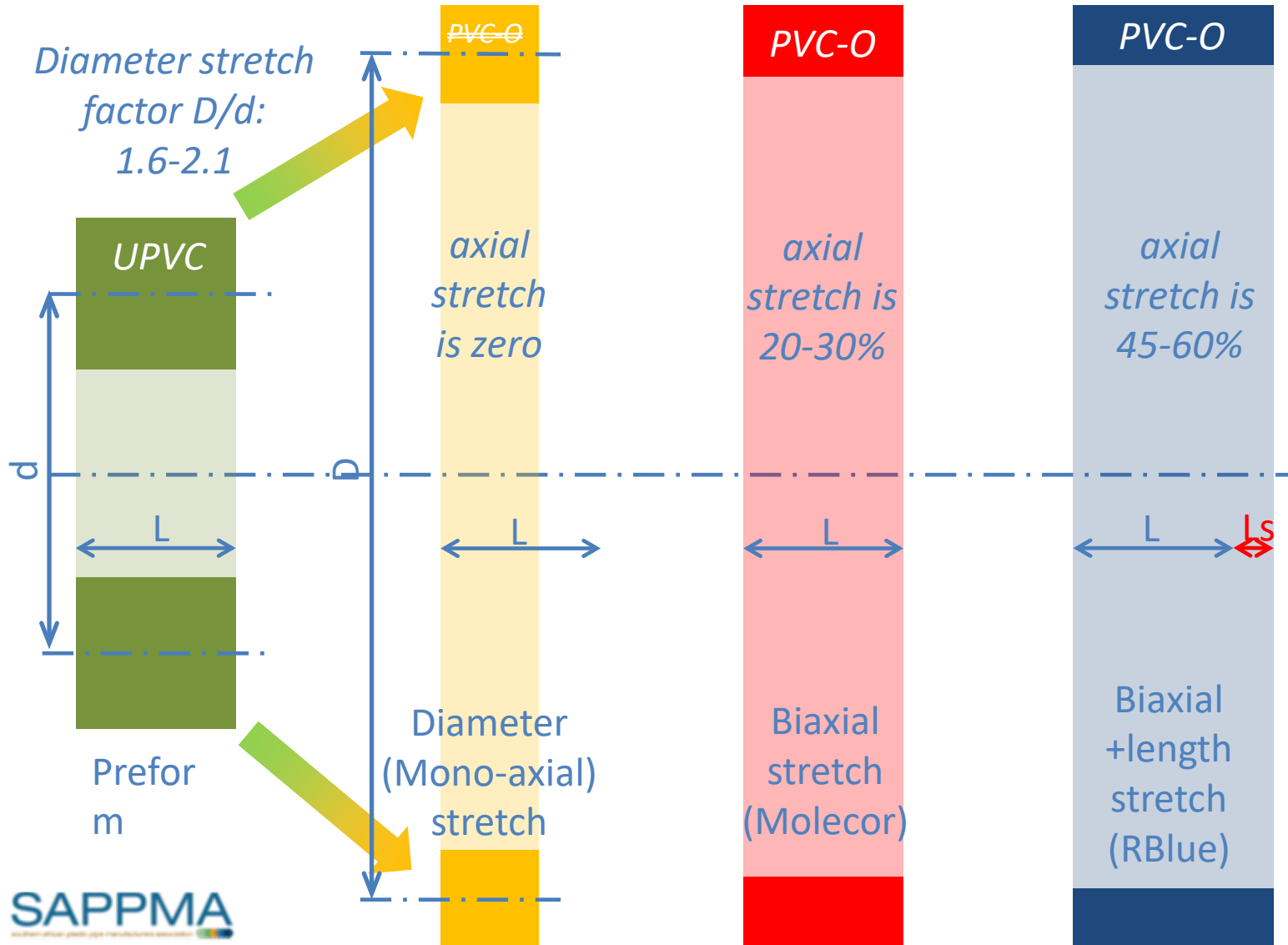

Practice has learned that the quality of the pipe is similar, but the quality of the integral socket in sustained pressure testing is optimal at 15-20% additional length stretch.



# PVC-O properties

1. High Tensile Strength
2. High Impact Strength

PVC-O pipe is a lightweight pressure pipe with superior properties



# PVC-O properties

Pipe strength depends on amount of deformation.

|       | MRS class | diameter stretch |
|-------|-----------|------------------|
| UPVC  | 250       | n.a.             |
| PVC-O | 315       | 160%             |
| PVC-O | 355       | 170%             |
| PVC-O | 400       | 180%             |
| PVC-O | 450       | 190%             |
| PVC-O | 500       | 210%             |



# PVC material saving up to 61%

| material class | C   | pressure class [Bar] |    |    |    |    |    |  |      |  |    | saving [%] |
|----------------|-----|----------------------|----|----|----|----|----|--|------|--|----|------------|
| UPVC: 250      | 2   |                      | 6  |    | 8  |    | 10 |  | 12,5 |  | 16 | 0          |
| PVC-O: 450     | 1,4 |                      | 16 |    | 20 |    | 25 |  |      |  |    | 57%        |
| PVC-O: 500     | 1,4 | 16                   |    | 20 |    | 25 |    |  |      |  |    | 61%        |

| DN [mm] | SDR->    | 45,8 | 41  | 37  | 33   | 29   | 26   | 23,4 | 21   | 19   | 17   |
|---------|----------|------|-----|-----|------|------|------|------|------|------|------|
| 110     | s [mm]-> | 2,4  | 2,7 | 3,1 | 3,4  | 3,8  | 4,2  | 4,7  | 5,3  | 5,9  | 6,6  |
| 160     | s [mm]-> | 3,5  | 4   | 4,4 | 4,9  | 5,5  | 6,2  | 6,9  | 7,7  | 8,5  | 9,5  |
| 200     | s [mm]-> | 4,4  | 4,9 | 5,5 | 6,2  | 6,9  | 7,7  | 8,6  | 9,6  | 10,7 | 11,9 |
| 250     | s [mm]-> | 5,5  | 6,2 | 6,9 | 7,7  | 8,6  | 9,6  | 10,7 | 11,9 | 13,3 | 14,8 |
| 315     | s [mm]-> | 6,9  | 7,7 | 8,7 | 9,7  | 10,8 | 12,1 | 13,5 | 15   | 16,8 | 18,7 |
| 400     | s [mm]-> | 8,8  | 9,8 | 11  | 12,3 | 13,7 | 15,3 | 17,1 | 19,1 | 21,3 | 23,7 |

PVC-O pipe Standard ISO 16422





# PVC-O Weight Savings

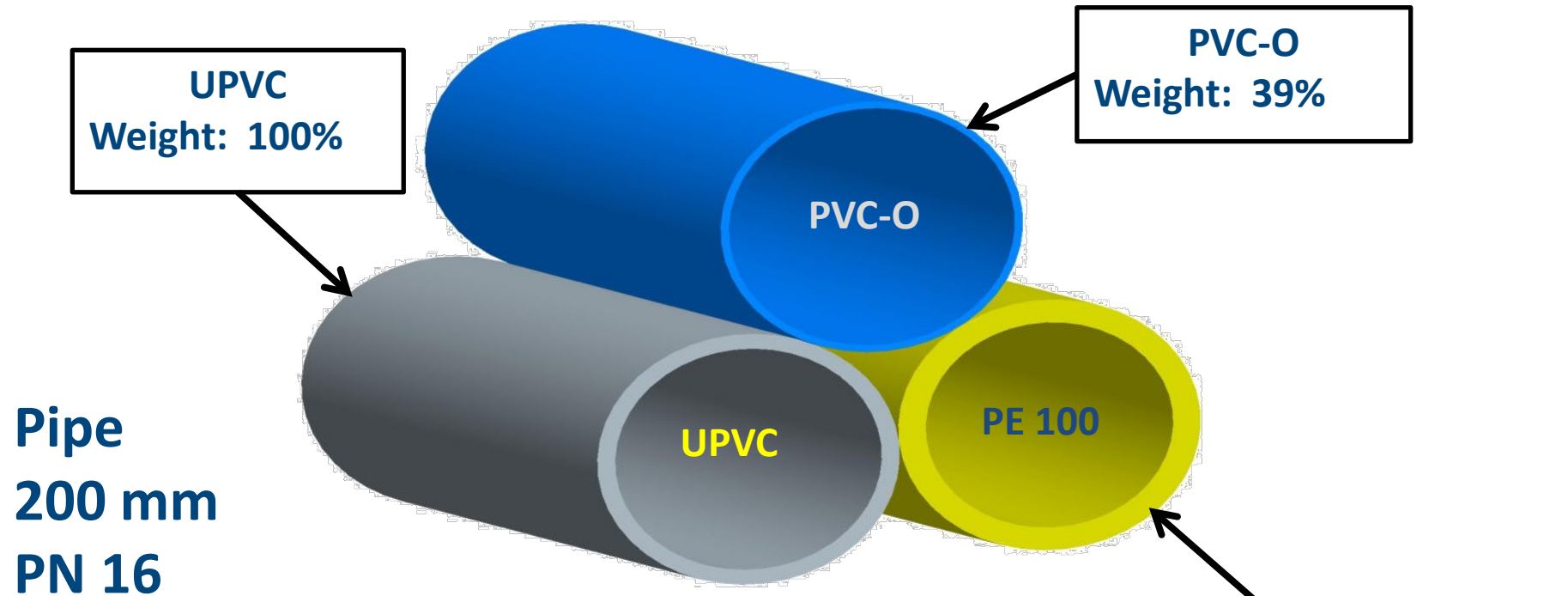

| material | SDR  | dimension | weight/m |
|----------|------|-----------|----------|
| PE 100   | 11   | 200x18,2  | 10.500   |
| UPVC     | 17   | 200x11,9  | 10.030   |
| PVC-O    | 45,8 | 200x4,4   | 3.860    |

PVC-O - Best in Class Pressure Pipe

13-4-2023



# PVC-O low hydraulic resistance

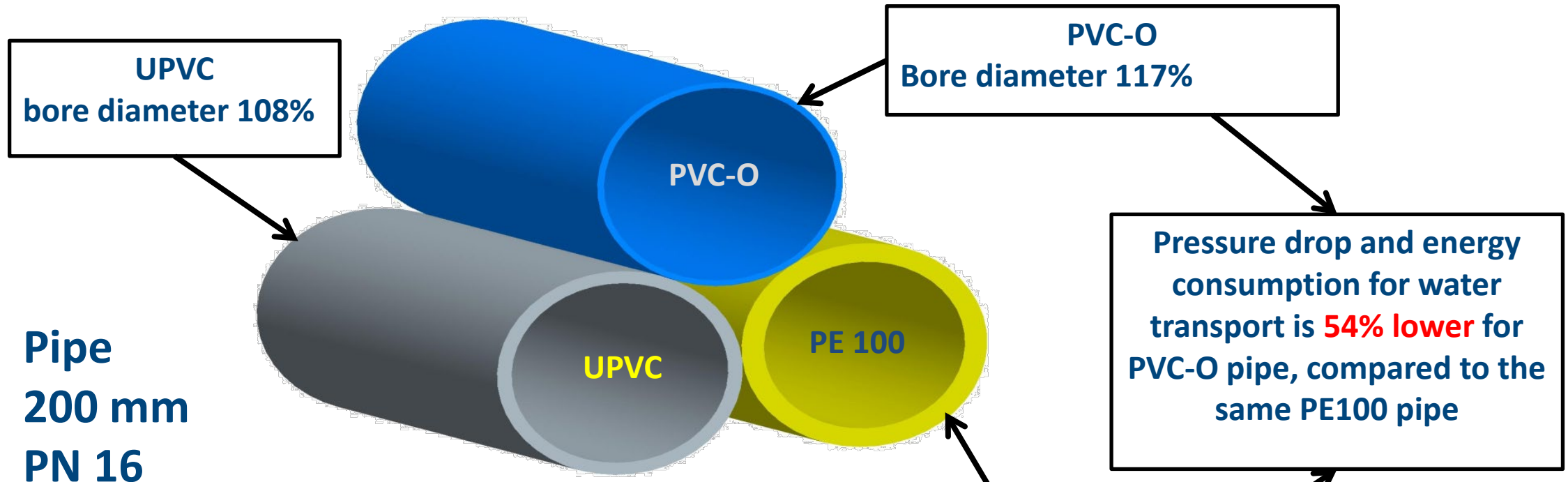

Pipe  
200 mm  
PN 16

| material | SDR  | dimension | bore diameter |
|----------|------|-----------|---------------|
| PE 100   | 11   | 200x18,2  | 163,6         |
| UPVC     | 17   | 200x11,9  | 176,2         |
| PVC-O    | 45,8 | 200x4,4   | 191,2         |

$$H2 = \left(\frac{d1}{d2}\right)^5 * H1$$



# PVC-O low hydraulic resistance

RBlue:

Pipe-bore is extremely smooth because the pipe is stretched on a solid mandrel

this results in an additional reduction of hydraulic resistance



# PVC-O: ultra high impact resistance

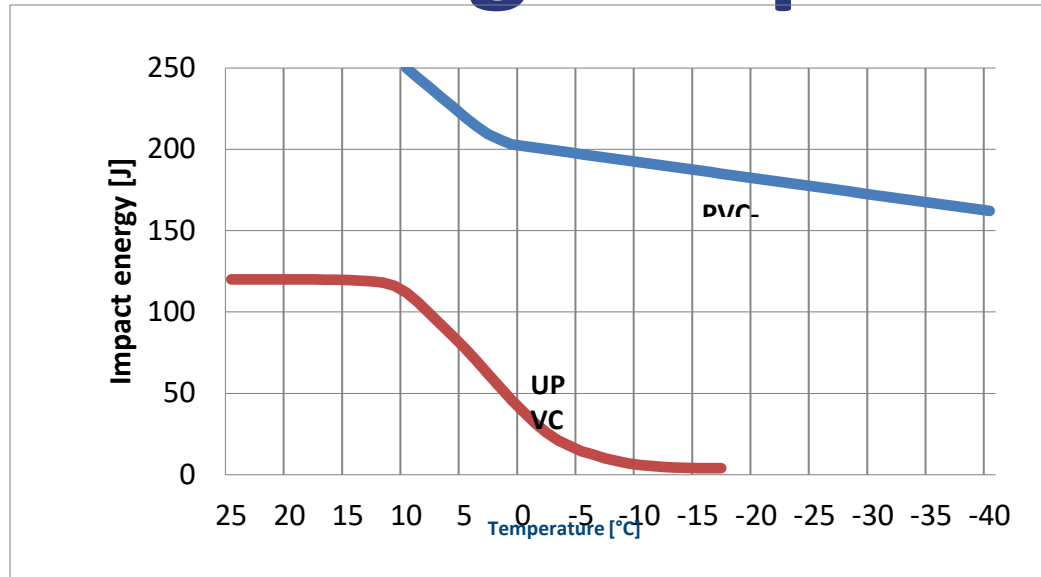

[Iplex Bionax commercial](#)

at 25C/77F: 5 times higher than UPVC

at -18C/0F: still much higher than UPVC at 25C/77F

Can be transported and installed in winter conditions



# PVC-O: ultra high impact resistance

- High cycle force resistance (water hammer)
- No recorded fast crack propagation
- Lower installation cost, as price of backfill is much lower (particle shape and size)



# PVC-O: High SDR pipe

High Flexibility for same pressure class



Simple curving:  
Less couplers with  
small degrees

Lowest weight  
(easy handling)





# PVC-O: Earthquake resilience

ULTRA BLUE PVCO C909



## EXCELLENT PROPERTIES FOR SEISMIC APPLICATIONS

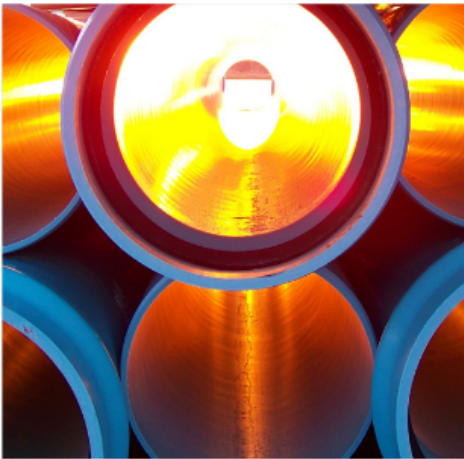

The biaxial orientation and the extended bell of JM Eagle's Ultra Blue PVCO C909 pipe provide excellent pipe and joint flexibility/adaptability which is specifically required for seismic water pipes. Independent researchers challenged the efficacy of biaxial oriented pipe testing it at Cornell University.

It was concluded that PVCO is the best material to implement in seismically sensitive terrains, in particularly areas subject to permanent ground deformation or liquefaction, the most damaging type of earthquake destruction.

### FACT

*In the  
Christchurch, NZ  
6.1 earthquake,  
PVCO  
pressure pipe remained  
completely undamaged  
during the main earthquake,  
liquefaction and  
all aftershocks!*



# PVC-O: Lowest Carbon Footprint

PE :100% non-renewable fossil fuel

PVC : 43% non-renewable fossil fuel

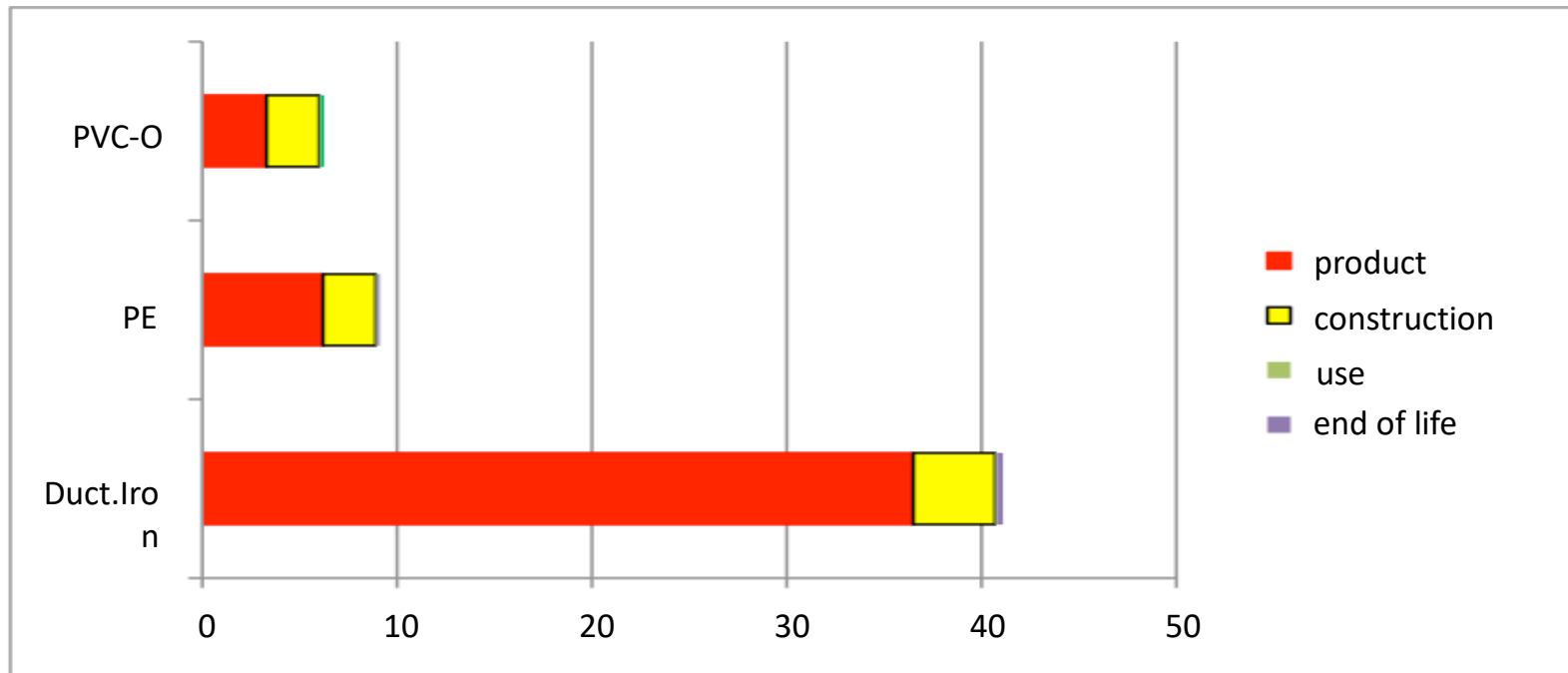





# PVC-O and bio-film

In PE drinking water pipelines, bio-film develops on the internal wall of the pipe, forcing drinking water companies to take measures.

In UPVC and PVC-O drinking water pipelines, bio-film hardly develops.

The smooth inner wall of RBlue pipe extra helps to avoid bio film.



# PVC-O and Chlorinated Water

PE pipes can be damaged by chlorinated drinking water, resulting in cracks.

(Thomas Steel, Solvay 2011)

PVC pipes cannot be damaged by chlorinated drinking water.



# Why PVC-O

Summary:

1. Excellent mechanical properties
2. Less use of material
3. Lowest Hydraulic Resistance
4. Lowest use of energy to produce
5. Lowest Carbon Footprint
6. No Biofilm

**PVC-O is most sustainable**



# The Price of PVC-O pipe

PVC-O pipe is produced with 45% lower costprice per meter pipe

Most of the PVC-O pipe in the world is sold with a higher price per meter than UPVC due to:

- Superior mechanical properties
- Lower Hydraulic Resistance or smaller OD
- Cheaper backfill in trench technology



# PVC-O, good to remember

- The formulation of PVC-O = UPVC pressure pipe formulation
- PVC-O is made from UPVC preform pipe at temp appr. 100°C / 212F
- Max. temperature of application for PVC-O is equal to UPVC
- PVC-O can be recycled together with UPVC
- PVC-O applies to standards: ISO 16422, AWWA C909, ASTM F 1483, AS/NZS 4441, NTC 5425, NBR 15750, IS 16647

# PVC-O Pipe Production

Two different ways:

1. Off-line (batch) process
2. In-line (continuous) process



# PVC-O Batch Process

1. Produce preform pipe (feedstock) with excellent wall thickness distribution and perfect welding line quality
2. Cut this preform pipe in pieces (6,5 m)
3. Heat these pieces up to stretching temperature
4. Insert preform in mould, clamp pipe ends, expand pipe in mould, cool down pipe, remove expanded pipe from mould
5. Cut off unexpanded pipe ends



# PVC-O Inline Process

1. Produce preform pipe (feedstock) with excellent wall thickness distribution and perfect welding line quality
2. Cool down and condition pipe to stretching temperature
3. Expand pipe on mandrel in continuous process, cool down and cut pipe without loss of material on any length
4. Optimize and control pipe dimensions continuously
5. If desired, form Socket to pipe in inline socketing machine

[Sica PVC-O Rieber socketing commercial](#)





# PVC-O Technologies

## Stretching technology

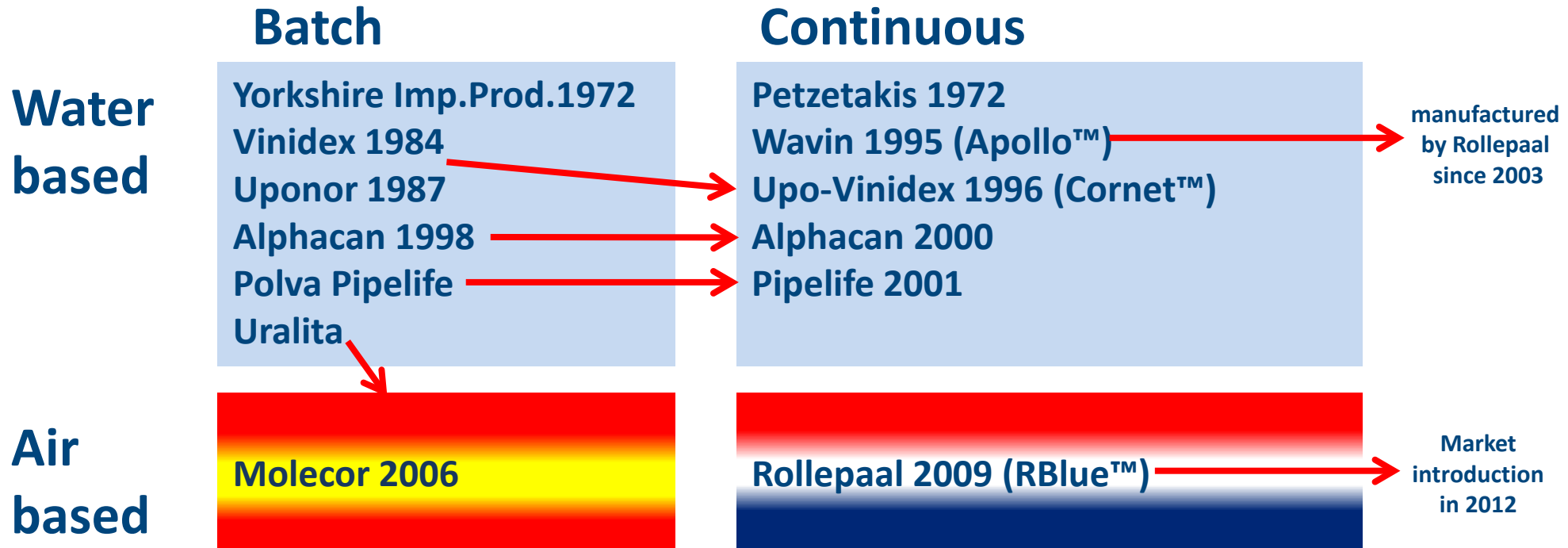



# RBlue extrusion line

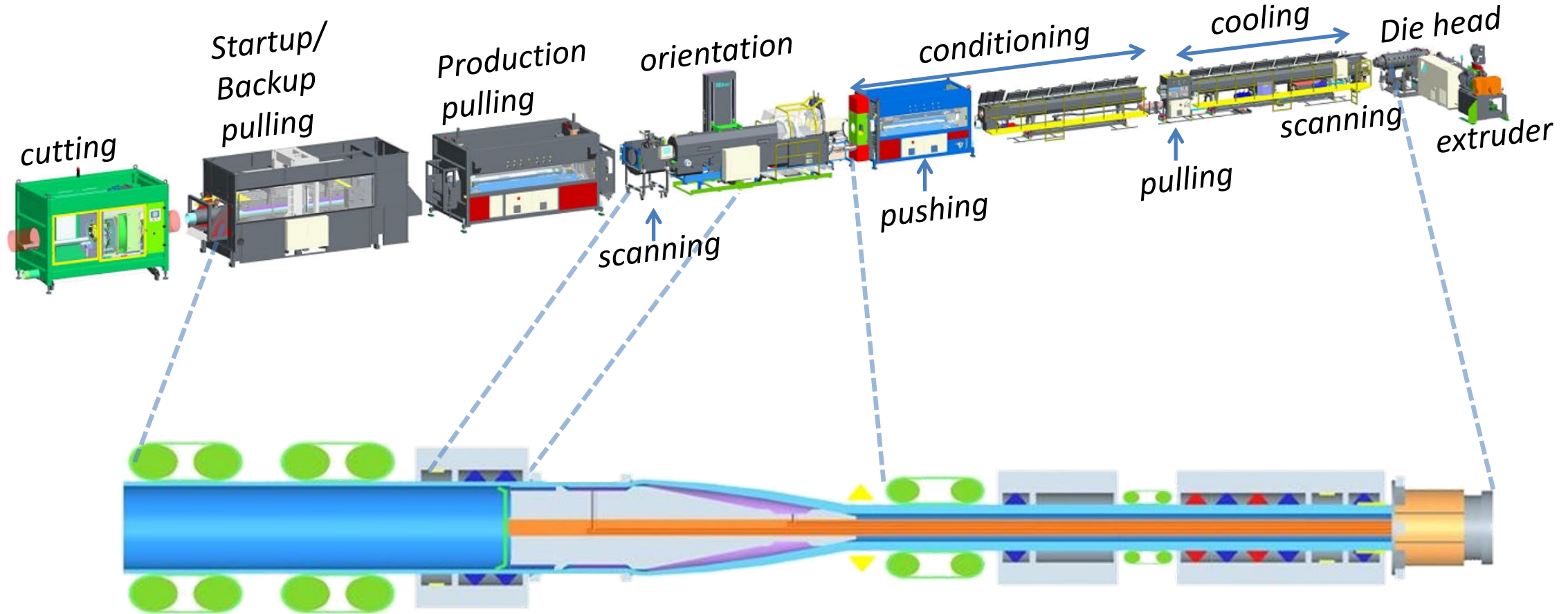



# PVC-O Batch vs Continuous

## Batch process advantages:

1. Belling can be included in the mould
2. Theoretical no limits in diameter
3. Quick startup
4. High output for large diameter pipe, provided feedstock is available



# PVC-O Batch vs Continuous

## Batch process disadvantages:

1. Machining and scrap for each pipe
2. Relatively high overweight due to unequal stretching
3. Fixed pipe length
4. No length stretching
5. No integrated Quality Control
6. Higher energy consumption if pipe is heated and cooled two times
7. Low output for small pipe diameters due to process cycle time
8. Surface quality of sealing area in integrated socket can be insufficient



# PVC-O Batch vs Continuous

## Continuous process disadvantages:

1. Relative long startup time -> typical length of production run shall be 100 h or more
2. More complex line control
3. More sensitive to ambient conditions



# PVC-O Batch vs Continuous

## Continuous process advantages:

1. Lowest Overweight through inline wall thickness control and presence of parameters to adjust and optimize
2. Smooth pipe bore
3. Variable pipe length (save cost of joints)
4. Flexibility in Socket and seal design, high quality of sockets
5. High production speeds
6. Continuous control and data storage of process parameters (set points and actual values)
7. Early warnings from process to prevent reject
8. Traceability of process conditions

Practice Values of overweight\*: **Batch 8-18 %** **Continuous 3-5 %**

\* Overweight is all weight in the pipe, more than the minimum wall thickness in the applicable standard



# PVC-O Batch vs Continuous

## Don't forget:

- In Batch process, cost of preform-extrusion line must be added to the investment
- In Continuous process, cost of socketing equipment must be added to the investment
- Space requirement (square meters) is the same for batch and continuous Process
- Line Length of Rblue extrusion line is shorter than a PE-100 line with same pressure class and same output in meters/hour.



# Optimal feedstock quality

To make optimal PVC-O pipe, you need:

1. UPVC preform with uniform wallthickness, lowest waviness, good welding lines and flawless pipe surface.
2. A uniform processing temperature in the pipe when stretching
3. Uniform distributed forces to stretch the pipe for equal MRS value





# Optimal feedstock quality

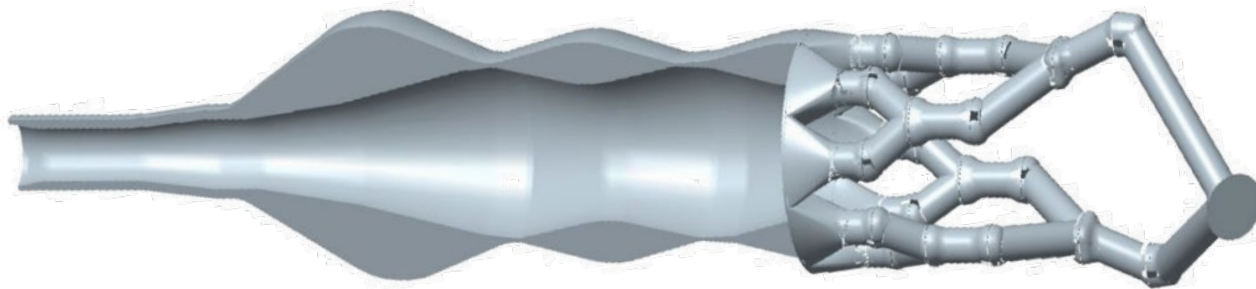

1. Optimal screw design
2. Triple Compression Die
3. Automatic Thermal Centering

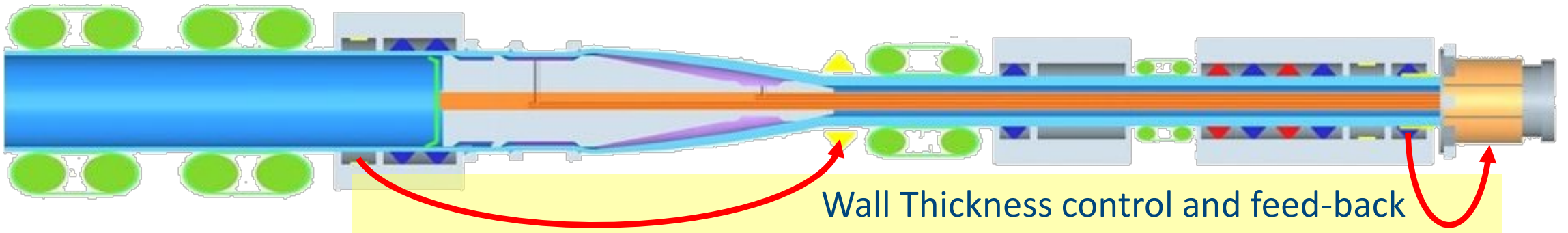



# Optimal Temperature Distribution

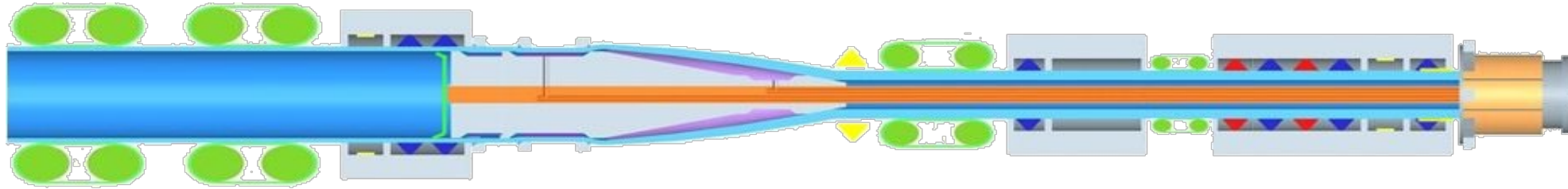

heating/cooling

Uniform processing temperature throughout the pipe  
gives most uniform MRS distribution

Cooling / conditioning process designed by means of FEM simulation



# The Key process parameters: Preform Temperature Profile

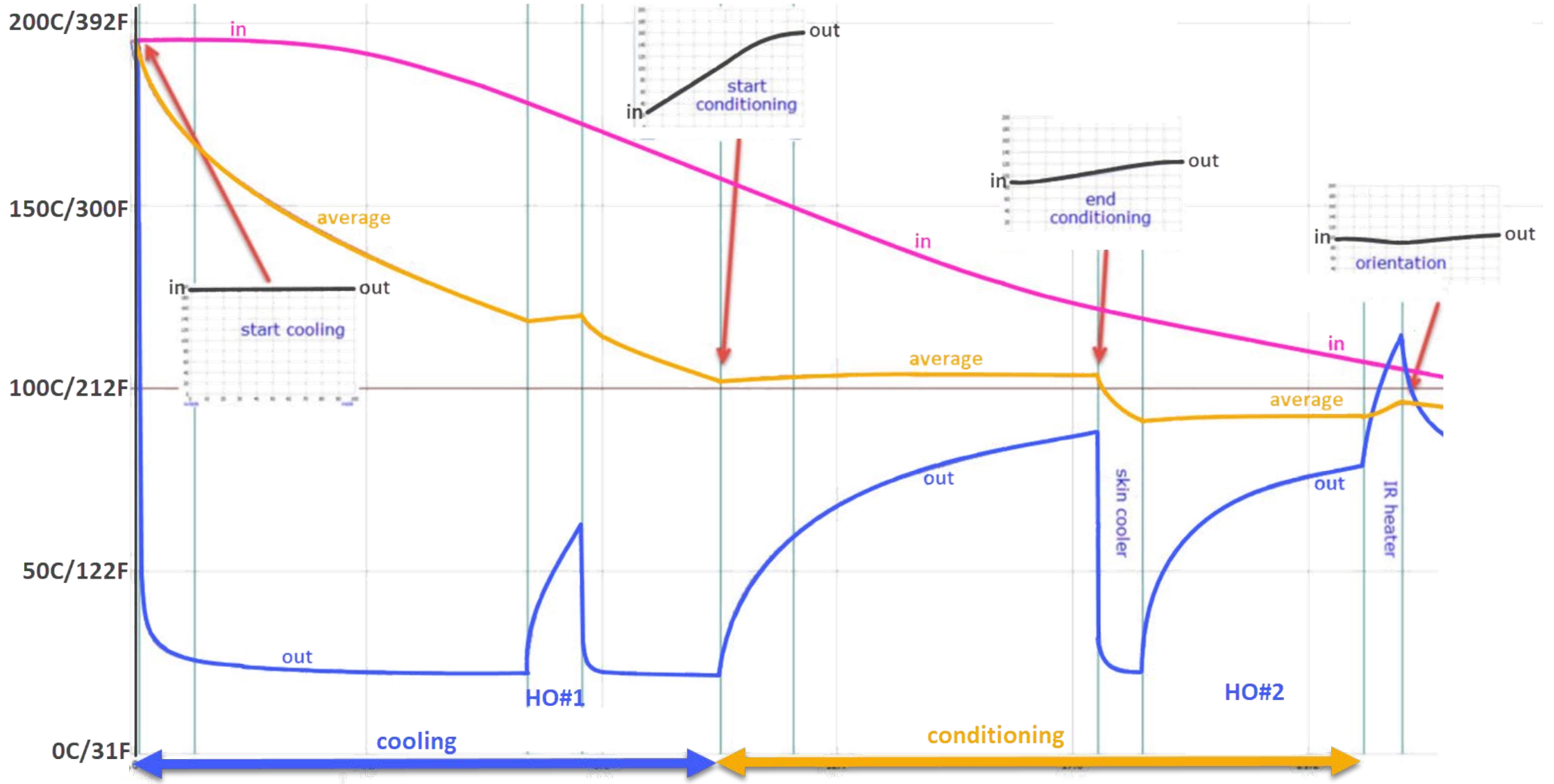



# Rblue air based in-line processing

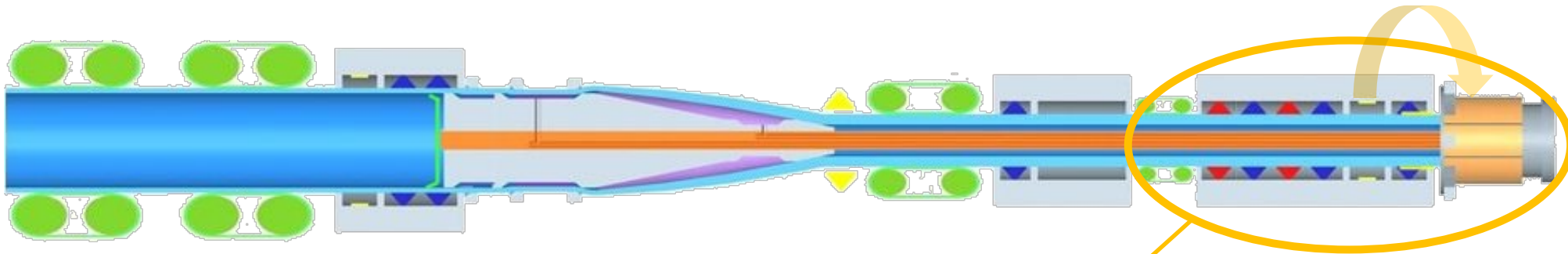

- 1. Create a preform with uniform wallthickness and 100% welding line strength**
2. Establish a uniform and optimal temperature profile for optimal orientation
3. Expand the pipe, supported by compressed and conditioned air
4. Calibrate and Cool the pipe, supported by compressed and conditioned air
5. Create length orientation by controlling the speed of the pullers
6. Cool the pipe, measure and optimize the wall thickness
7. Run the line automatic on Air Control, Wall Thickness Control, and Force Control



# Rblue air based in-line processing

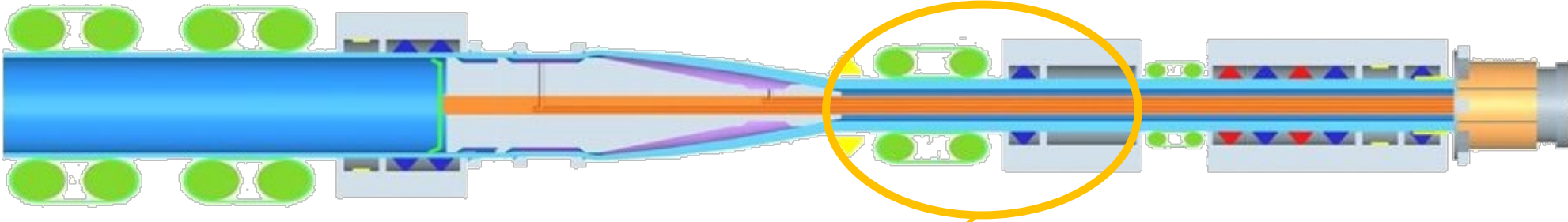

1. Create a preform with uniform wallthickness and 100% welding line strength
- 2. Establish a uniform and optimal temperature profile for optimal orientation**
3. Expand the pipe, supported by compressed and conditioned air
4. Calibrate and Cool the pipe, supported by compressed and conditioned air
5. Create length orientation by controlling the speed of the pullers
6. Cool the pipe, measure and optimize the wall thickness
7. Run the line automatic on Air Control, Wall Thickness Control, and Force Control



# Rblue air based in-line processing

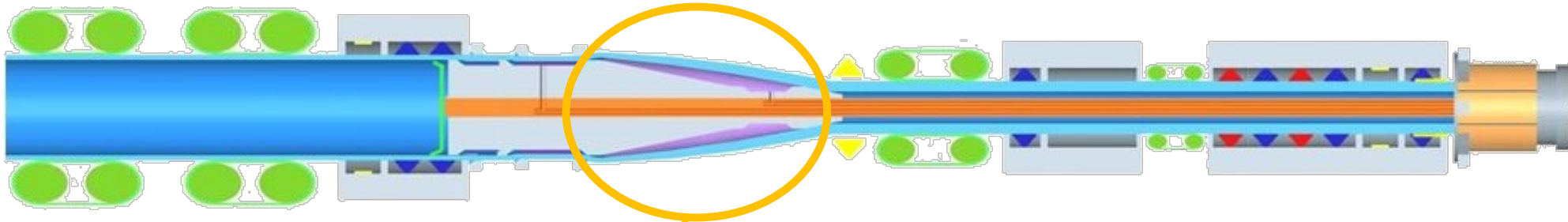

1. Create a preform with uniform wallthickness and 100% welding line strength
2. Establish a uniform and optimal temperature profile for optimal orientation
- 3. Expand the pipe, supported by compressed and conditioned air**
4. Calibrate and Cool the pipe, supported by compressed and conditioned air
5. Create length orientation by controlling the speed of the pullers
6. Cool the pipe, measure and optimize the wall thickness
7. Run the line automatic on Air Control, Wall Thickness Control, and Force Control



# Rblue air based in-line processing

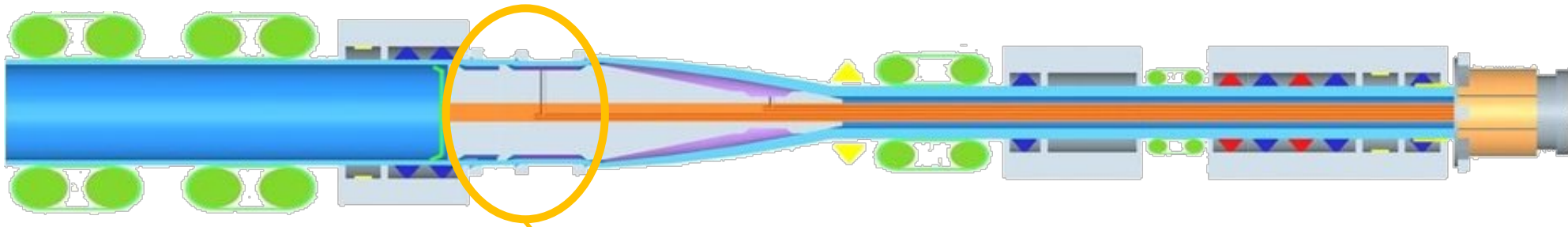

1. Create a preform with uniform wallthickness and 100% welding line strength
2. Establish a uniform and optimal temperature profile for optimal orientation
3. Expand the pipe, supported by compressed and conditioned air
- 4. Calibrate and Cool the pipe, supported by compressed and conditioned air**
5. Create length orientation by controlling the speed of the pullers
6. Cool the pipe, measure and optimize the wall thickness
7. Run the line automatic on Air Control, Wall Thickness Control, and Force Control

# Rblue air based in-line processing

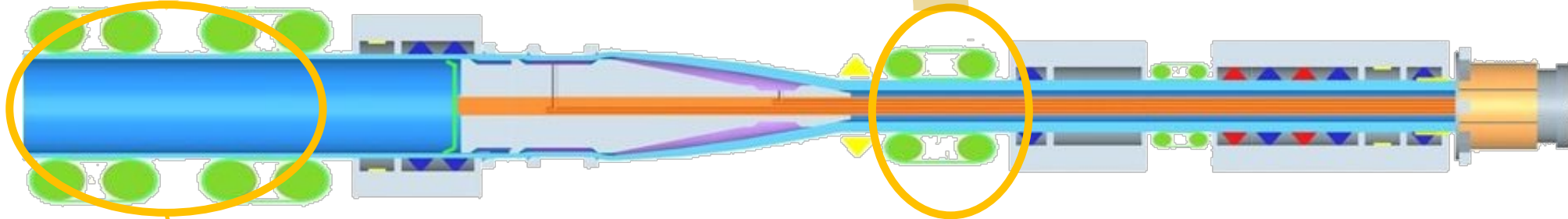

1. Create a preform with uniform wallthickness and 100% welding line strength
2. Establish a uniform and optimal temperature profile for optimal orientation
3. Expand the pipe, supported by compressed and conditioned air
4. Calibrate and Cool the pipe, supported by compressed and conditioned air
- 5. Create length orientation by controlling the speed of the pullers**
6. Cool the pipe, measure and optimize the wall thickness
7. Run the line automatic on Air Control, Wall Thickness Control, and Force Control





# Rblue air based in-line processing

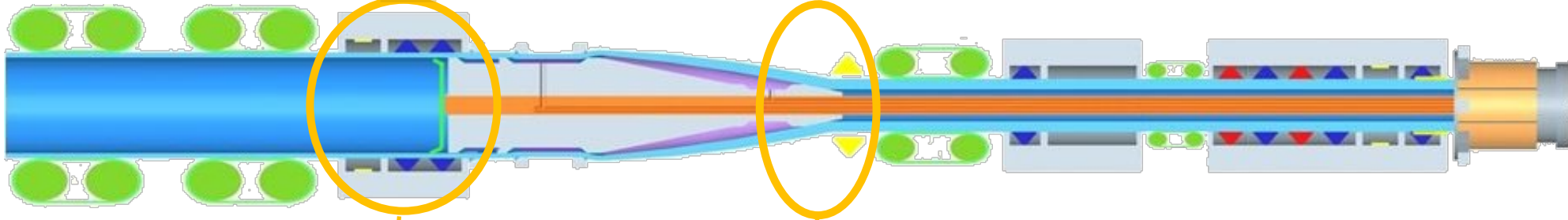

1. Create a preform with uniform wallthickness and 100% welding line strength
2. Establish a uniform and optimal temperature profile for optimal orientation
3. Expand the pipe, supported by compressed and conditioned air
4. Calibrate and Cool the pipe, supported by compressed and conditioned air
5. Create length orientation by controlling the speed of the pullers
- 6. Cool the pipe, measure and optimize the wall thickness**
7. Run the line automatic on Air Control, Wall Thickness Control, and Force Control



# Rblue air based in-line processing

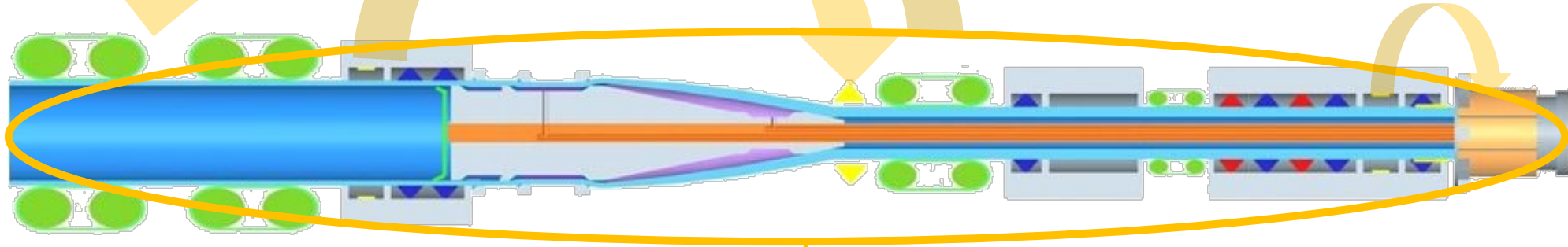

1. Create a preform with uniform wallthickness and 100% welding line strength
2. Establish a uniform and optimal temperature profile for optimal orientation
3. Expand the pipe, supported by compressed and conditioned air
4. Calibrate and Cool the pipe, supported by compressed and conditioned air
5. Create length orientation by controlling the speed of the pullers
6. Cool the pipe, measure and optimize the wall thickness
- 7. Run the line automatic on Air Control, Wall Thickness Control, and Force Control**



# RBlue extrusion line

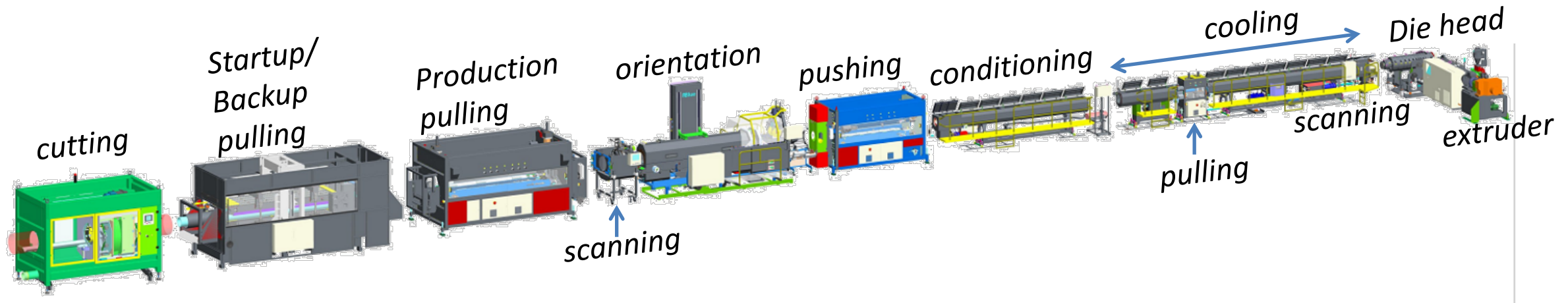



# RBlue

- Offset die to create free passage for pulling bar
- Extruder configuration 90° or 45°
- Extruder position Left- or Right side
- Continuous recording force in pulling bar

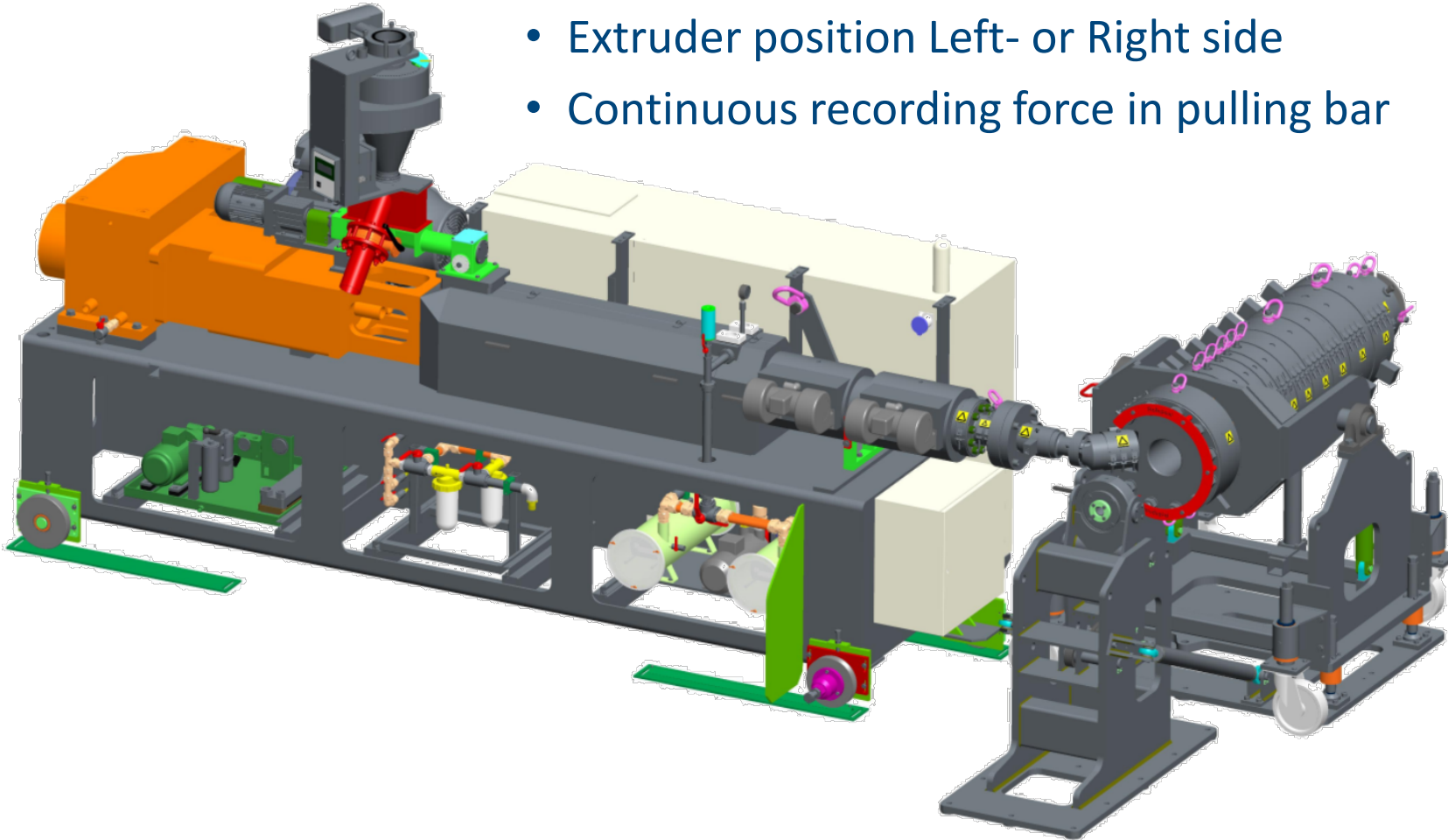

# RBlue



- Offset die to create free passage for pulling bar
- Extruder configuration 90° or 45°
- Extruder position Left- or Right side
- Continuous recording force in pulling bar

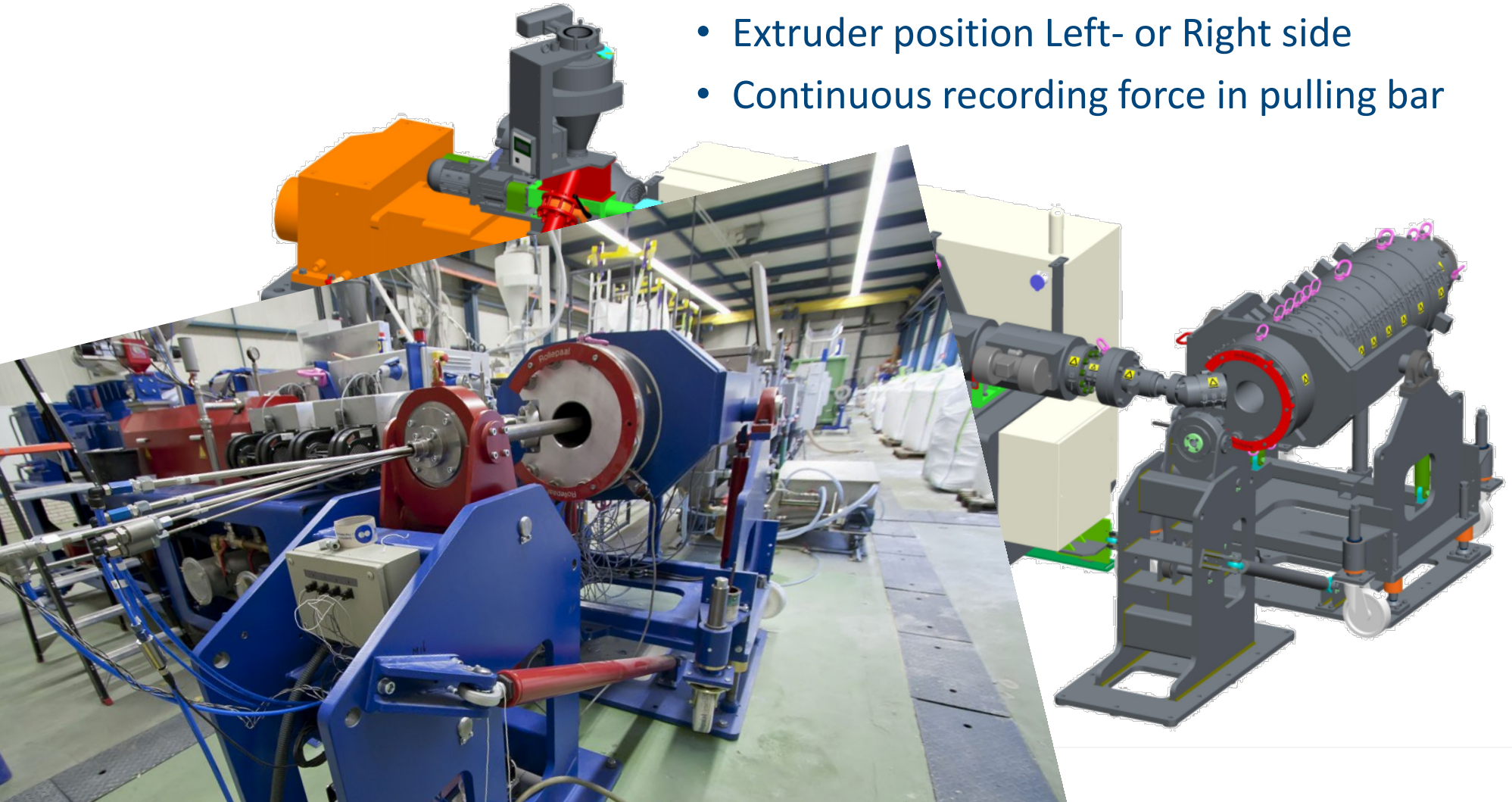



# RBlue

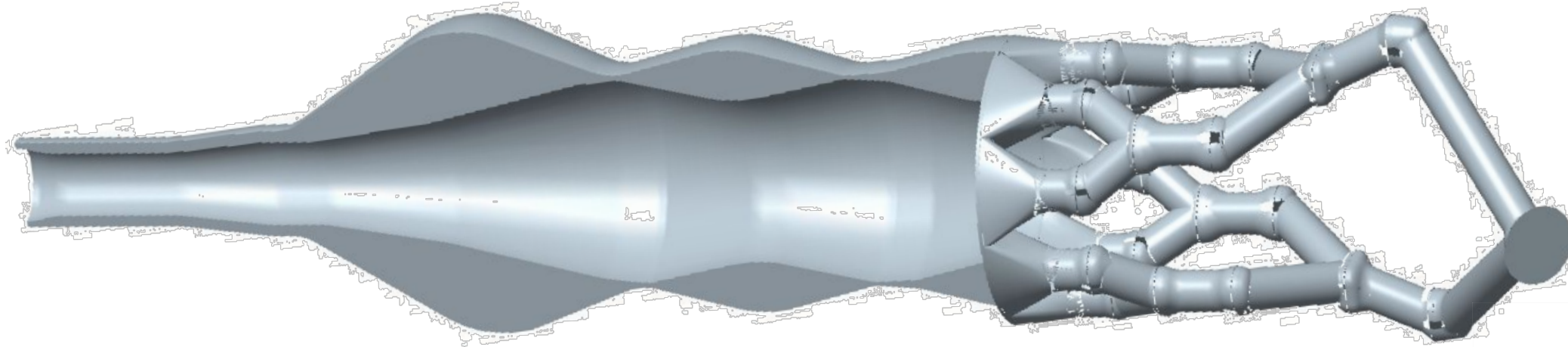

- Rollepaal patented branching for offset die technology
- Triple Compression tooling for optimal wall thickness distribution and full welding quality
- Open die head center allows for pipe inside air cooling
- Automatic Thermal Centering

# RBlue

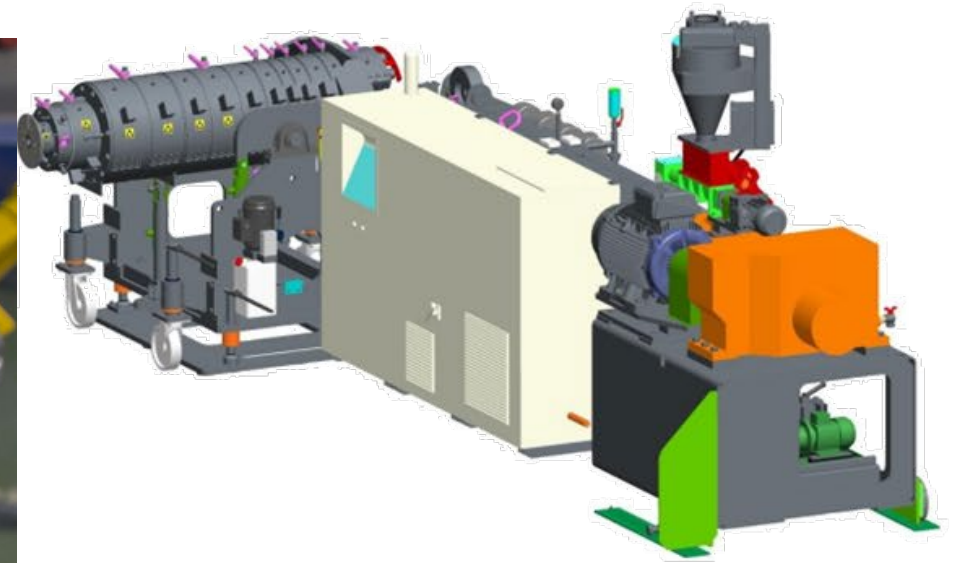
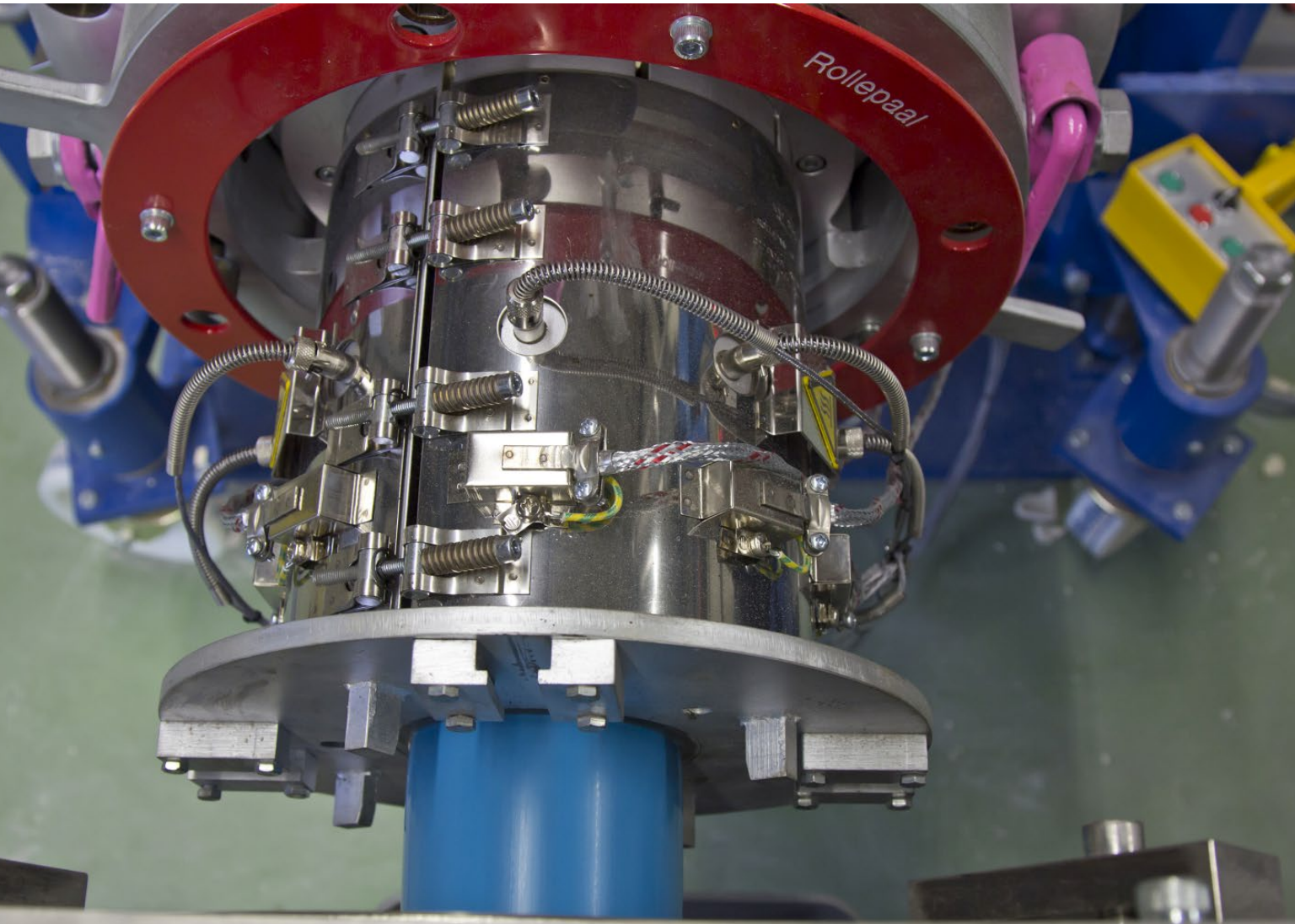

Automatic  
Thermal  
Centering

# Preform inside air cooling

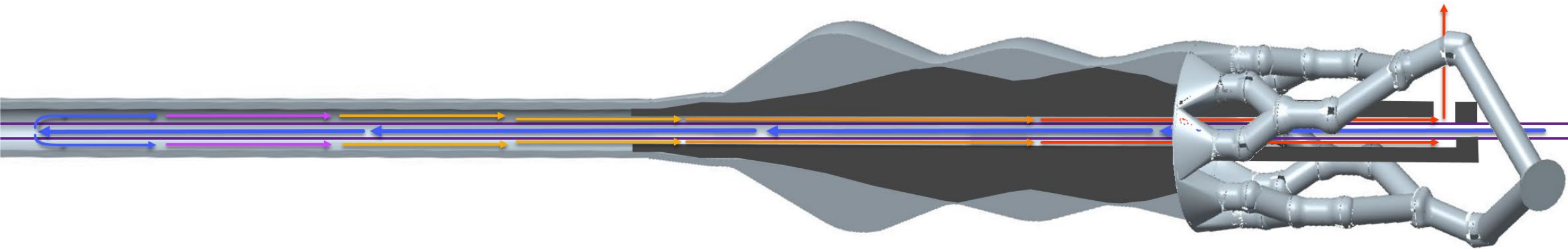

- Enable large preform wall thickness (>70 mm)
- Prevent discoloration of pipe bore
- Increase processing window
- Increase line output





rollepaal

FLUKE

12.6 10.1

RBlue

*testrun AWWA C909 24"-235psi (655 x 21 mm), april 2020*



# Remote data-driven support

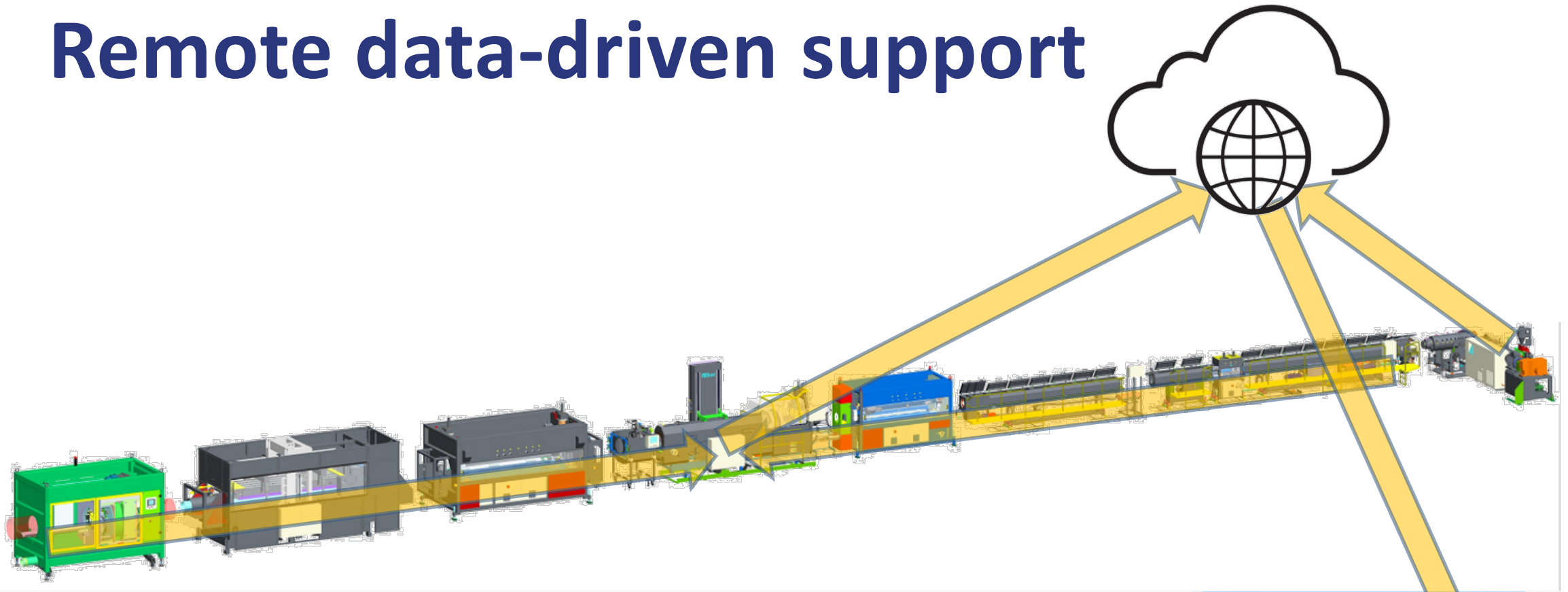

- Online database with daily upload of all parameters
- Instant support for problems
- Periodical analysis to evaluate performance
- Base for continuous improvement of the process





# Specs

- ISO: MRS 315-500, diameters 90-630mm, 12,5-25 Bar
- AWWA C909: diameters 4"-24", 165-235-305 psi
- Line 400: diam.90-406 mm (line length appr. 70m/230ft excl. socketing)
- Line 630: diam.315-666 mm (line length appr. 85m/280ft excl. socketing)
- Line Output up to 1.000 kg/h (2.200 lbs/h)
- Line Speed up to 300 m/h (1.000 ft/h)
- Inside preform cooling (air) for oriented pipe true OD >300 mm/12"



# Thank You



 **Rollepaal**  
Pipe Extrusion Technology

**Rollepaal Pipe Extrusion Technology BV**  
Rollepaal 13  
7701 BR Dedemsvaart  
The Netherlands

*Presenter*

*SAPPMA Webinar II 2023*

13 April 2023



Helmuth Rijnhart



**rollepaal**



**SAPPMA**  
southern african plastic pipe manufacturers association



# Standards to keep in mind

ISBN 978-0-626-35864-8

**SANS 17050-1:2013**  
Edition 1  
**ISO/IEC 17050-1:2004**  
Edition 1

**SOUTH AFRICAN NATIONAL STANDARD**

**Conformity assessment — Supplier's  
declaration of conformity**

**Part 1: General requirements**

ISBN 978-0-626-35863-1

**SANS 17050-2:2013**  
Edition 1  
**ISO/IEC 17050-2:2004**  
Edition 1

**SOUTH AFRICAN NATIONAL STANDARD**

**Conformity assessment — Supplier's  
declaration of conformity**

**Part 2: Supporting documentation**



# SANS 17050 Objective- Provides requirements for suppliers declaration of conformity

This part of SANS ISO/IEC 17050 specifies requirements applicable when the individual or organisation responsible

for the fulfilment of specified requirements (supplier) provides a declaration that a product (including service),

process, management system, person or body is in conformity with specified requirements, which can include

normative documents such as standards, guides, technical specifications, laws and regulations. Such a declaration of

conformity can also make reference to the results of assessments by one or more first, second

or third parties. Such references are not to be interpreted as reducing the supplier's responsibility in any way.

**declaration**  
noun  
dĕk"lə-rā'shən  
1. An explicit, formal announcement, either oral or written.  
2. The act or process of declaring.



# Three Types of Attestation of conformity

Attestation undertaken by the first party (e.g. the supplier of a product).

Other types are second-party attestation (e.g. where a user issues an attestation for the product the user is using)

Third-party attestation.

Each of these three types is used in the market in order to increase confidence in the conformity of an object.



# Attestation of conformity

These general requirements apply to all sectors. However, these requirements might need to be

supplemented for specific purposes, for example, for use in connection with regulations.

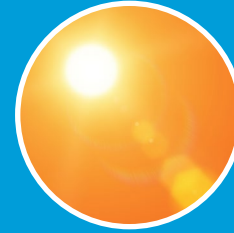

A supplier's declaration of conformity of a product (including service), process, management system, person



or body to specified requirements can be substantiated by supporting documentation under the responsibility of the supplier.

In cases where this is desirable or necessary, reference is made to SANS ISO/IEC 17050-2.

SAPPMA members are suppliers to keep in mind

# SAPPMA

southern african plastic pipe manufacturers association

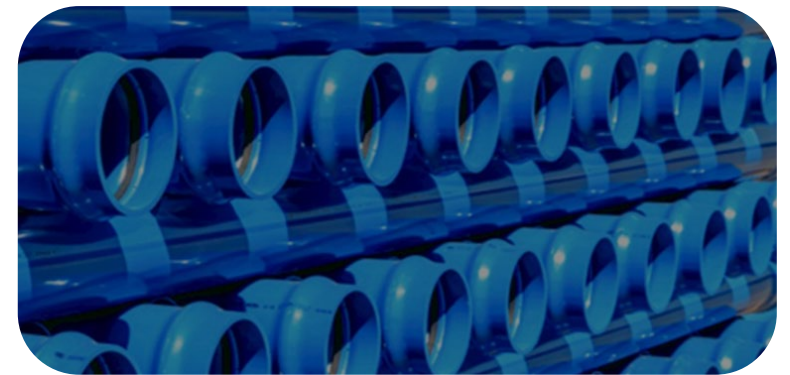

# Questions and Answers



[ian@sappma.co.za](mailto:ian@sappma.co.za)  
admin@sappma.co.za

